

CONCRETE PRODUCT NOTE:

1. REFER TO GENERAL TOLERANCES UNO
2. REFER TO DRAWING [50202853] COVER DETAIL
3. GRADE OF CONCRETE - CONCRETE 50MPA
4. ALL LIFTING POINTS TO BE USED WHEN LIFTING
5. MINIMUM STRENGTH OF CONCRETE SHALL BE 25MPA AT THE TIME OF LIFTING
6. COVER TO REINFORCEMENT TO BE 50mm
7. REFER TO ANCON LIFTING ARRANGEMENT PLAN

SURFACE FINISH

- TOP: BROOM FINISH
- SIDES: OFF FORM FINISH (CLASS 3, AS3610)

DESIGN LOADS:

1. CLASS D TRAFFIC DESIGN LOAD - AS3996:2019 & AS5100:2017

BOM:50207426_

ITEM #	QTY.	PART #	DESCRIPTION	MATERIAL
1	1	50206829	ENCASEMENT SOLID 1000x1000x250 WITH 600x600 CLASS D	
2	1	50207781	TAG BRASS TRANS NSW COMMUNICATIONS	BRASS

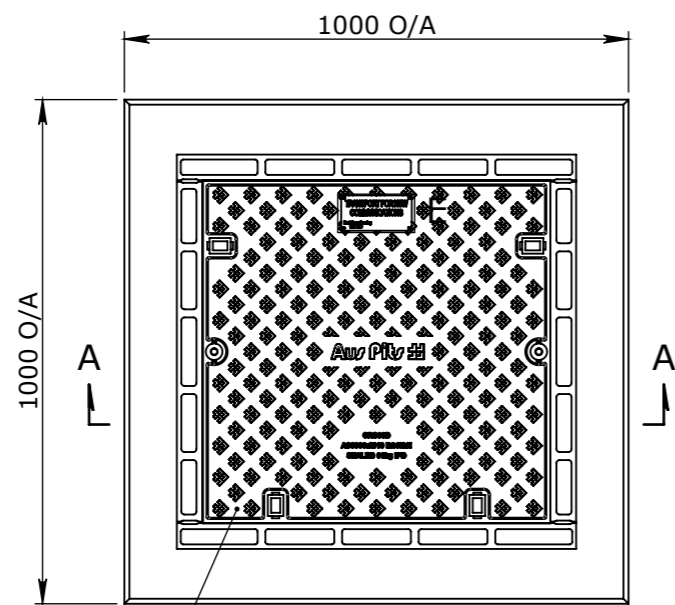

COVER AND FRAME SOLID 600x600 1 PART CLASS D (CRS66D)

PLAN VIEW

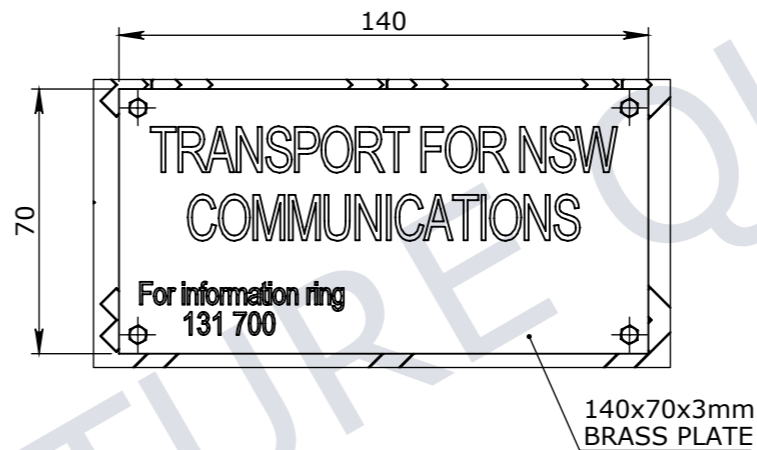

DETAIL E
SCALE_1:2

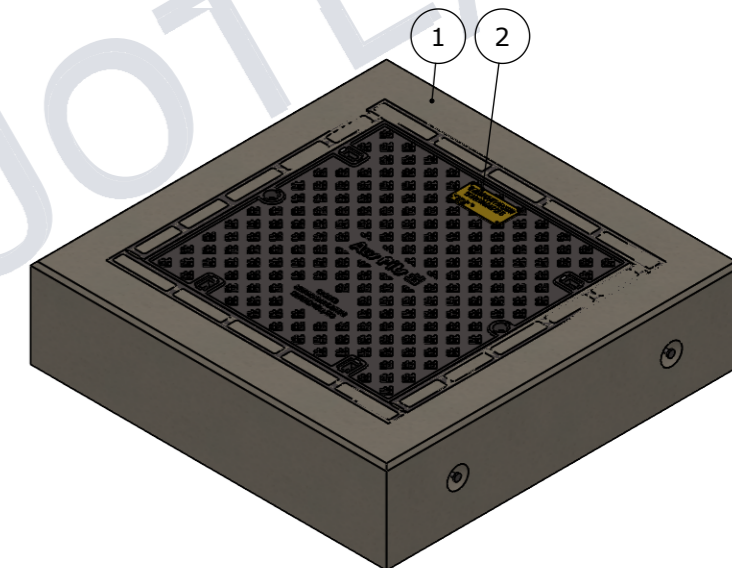

ISOMETRIC VIEW

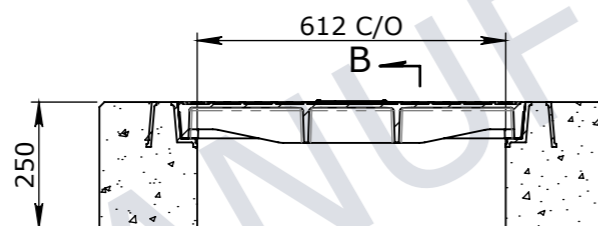

SECTION A-A

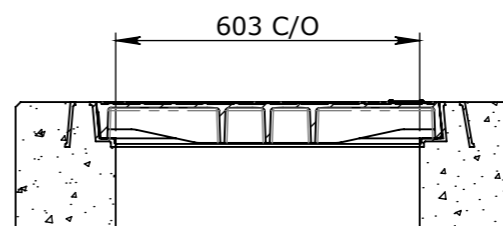

SECTION B-B

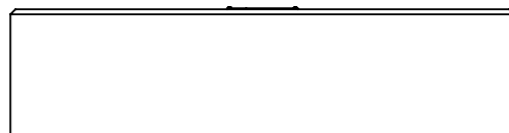

ELEVATION VIEW

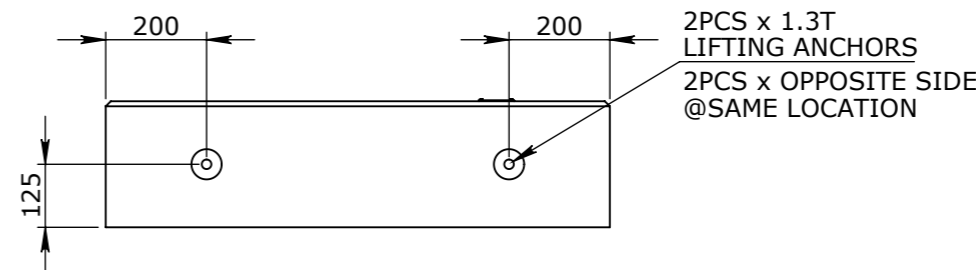

END VIEW

UNCONTROLLED DOCUMENT WHEN PRINTED

TOLERANCE NOTES:

1. CONCRETE TOLERANCES TO BE IN CONJUNCTION / ACCORDANCE WITH AS3600 - CONCRETE STRUCTURES
2. WHEN A BROOM FINISH IS REQUIRED THE GENERAL TOLERANCE SUPERCEDES THE FLATNESS TOLERANCE
3. WALL THICKNESS - DIMENSION AS NOTED IS MINIMUM THICKNESS ONLY
4. CONCRETE GRADE - 40MPA UNLESS NOTED OTHERWISE
5. DIMENSIONS ARE NOT INCLUSIVE OF SEALANTS OF JOINTS
6. SURFACE FINISH - CLASS 4 (AS3610.1)

Rev.	DESCRIPTION	DATE	BY	APPROVED
3				
2				
1				

GENERAL TOLERANCES		REVISION CONTROL	
NOMINAL:	UP TO 1000mm	1M AND ABOVE	FLATNESS: (NOT INCLUDING BROOME FINISH)
TOLERANCE:	±5mm	1mm IN 200mm UP TO A MAXIMUM OF 20mm	±4mm PER 1M WIDTH IN 1M LENGTH

CHK / APPR: Lee, Mia
DATE:
RPEQ DOCUMENT #:
WEIGHT: APPROX. 470Kg
MATERIAL:
IRF REF:

Infrastructure Products Australia
A CRH COMPANY

HEAD OFFICE:
1 REEVES COURT
BREAKWATER, VIC 3219
1800 065 356

ENGINEERING & DEVELOPMENT:
91 STRADBROKE STREET
HEATHWOOD, QLD 4110
(07) 3714 0444

DRAFTED DATE: 9/11/2023
DRAFTED BY:
DATE LAST SAVED: 27/11/2023
LAST SAVED BY: MLEE
DRAWN TO AS 1100 DO NOT SCALE FROM SHEET

PART/PRODUCT # 50207426	QUOTE #	ORDER #
REINFORCEMENT COMPUTATION AP-EC-CRS66D-ENC 1000X1000X250	PIT #	ITEM TYPE
CLIENT INFRASTRUCTURE PRODUCTS AUS	PROJECT DESC CATALOGUE PRODUCTS	
DRAWING NAME ENCASEMENT SOLID 1000X1000X250 WITH 600X600 WITH TRANS NSW TAG COMM CLASS D	DRAWING # 50207426	REV. 2
PAGE 1 / 1	SHEET SIZE A3	SCALE 1:15