

CULVERT NOTES:

1. REFER TO GENERAL TOLERANCES UNO
2. ALL LIFTING POINTS TO BE USED WHEN LIFTING
3. MINIMUM STRENGTH OF CONCRETE SHALL BE 25MPA AT THE TIME OF LIFTING
4. NOMINAL COVER TO REINFORCEMENT - 35MM
5. REFER TO ANCON LIFTING ARRANGEMENT PLAN
6. BOX CULVERTS COMPLIES TO AS1597.2-2013

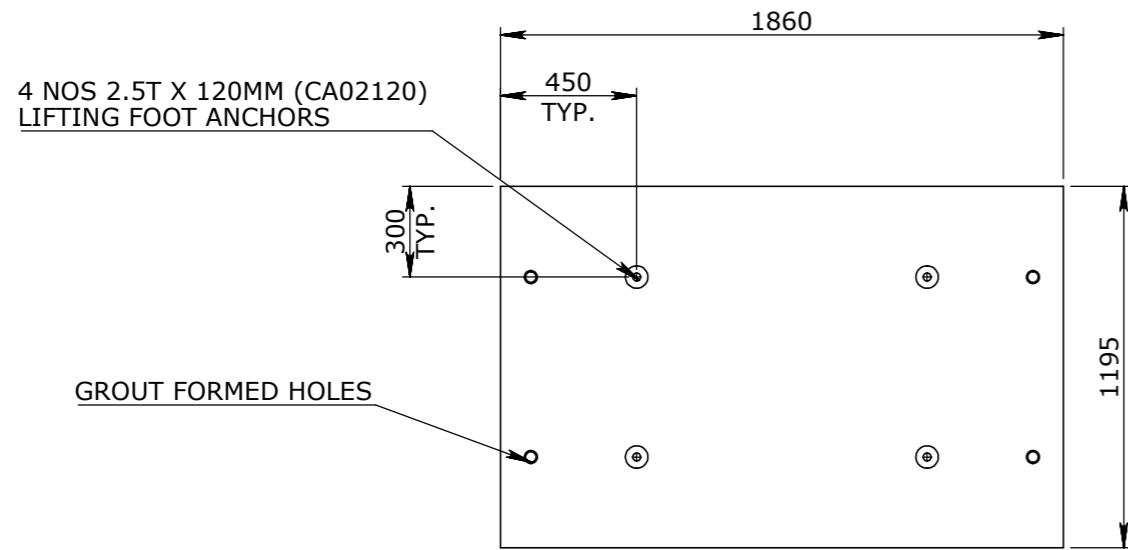

PLAN VIEW

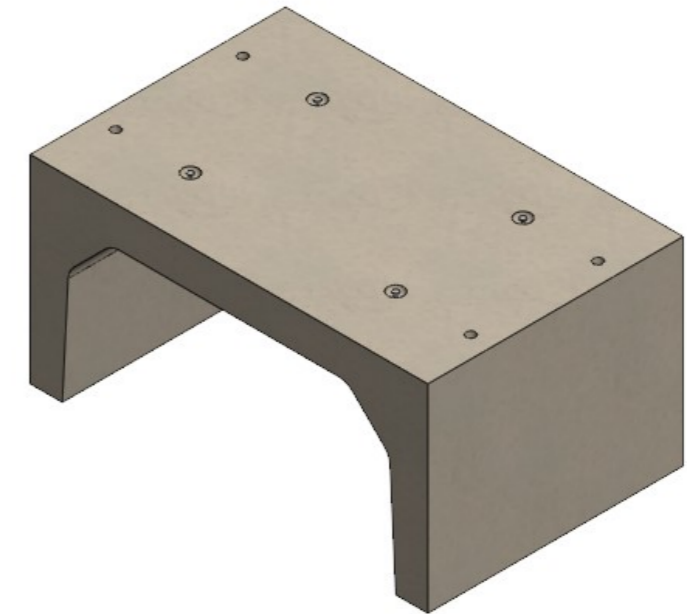

ISOMETRIC VIEW

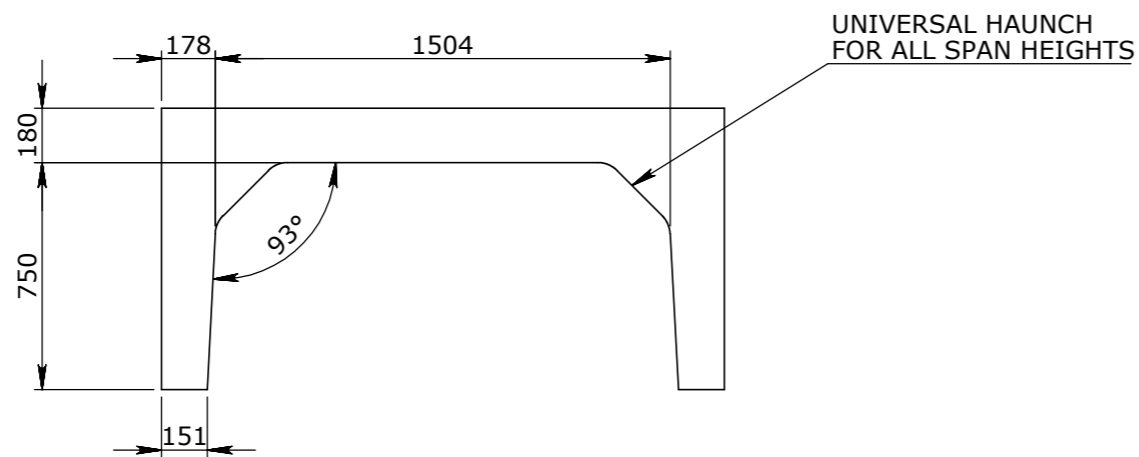

ELEVATION VIEW



END VIEW

UNCONTROLLED DOCUMENT WHEN PRINTED

TOLERANCE NOTES:

1. CONCRETE TOLERANCES TO BE IN CONJUNCTION / ACCORDANCE WITH AS3600 - CONCRETE STRUCTURES
2. WHEN A BROOME FINISH IS REQUIRED THE GENERAL TOLERANCE SUPERCEEDS THE FLATNESS TOLERANCE
3. WALL THICKNESS - DIMENSION AS NOTED IS MINIMUM THICKNESS ONLY
4. CONCRETE GRADE - 40MPA UNLESS NOTED OTHERWISE
5. DIMENSIONS ARE NOT INCLUSIVE OF SEALANTS OF JOINTS
6. SURFACE FINISH - CLASS 4 (AS3610.1)

Rev	DESCRIPTION	DATE	BY	APPROVED
3				
2				
1				

GENERAL TOLERANCES		REVISION CONTROL	
NOMINAL:	UP TO 1000mm	1M AND ABOVE	FLATNESS: (NOT INCLUDING BROOME FINISH)
TOLERANCE:	±5mm	1mm IN 200mm UP TO A MAXIMUM OF 20mm	±4mm PER 1M WIDTH IN 1M LENGTH

CHK / APPR: Revee Lein
DATE: M. Orozco
RPEQ DOCUMENT #:
WEIGHT: 1841.21Kg
MATERIAL: CONCRETE 50MPA
IRF REF:

Infrastructure Products Australia
A CRH COMPANY

HEAD OFFICE:
1 REEVES COURT
BREAKWATER, VIC 3219
1800 065 356

ENGINEERING & DEVELOPMENT:
91 STRADBROKE STREET
HEATHWOOD, QLD 4110
(07) 3714 0444

DRAFTED DATE: 24/01/2022
DRAFTED BY: D.PRUSAC
DATE LAST SAVED: 4/07/2022
LAST SAVED BY: ROROZCO
DRAWN TO AS 1100 DO NOT SCALE FROM SHEET

PART/PRODUCT # TMR CULVERT	QUOTE #	ORDER #
REINFORCEMENT COMPUTATION	PIT # 50207166	ITEM TYPE BOX CULVERTS
CLIENT CUBIS SYSTEMS	PROJECT DESC BOX CULVERTS	
DRAWING NAME BOX CULVERT TMR 1500x750-2A 1200mm NOMINAL LENGTH	DRAWING # 50207166	REV. 0
PAGE 1 / 1	SHEET SIZE A3	SCALE 1:25